



R-Shield®

NAILSTRIP

WALL APPLICATIONS CONSTRUCTION MANUAL

Note: Information deemed reliable at time of printing.
Please visit www.rshieldinsulation.com for the latest information.



WALL APPLICATIONS CONSTRUCTION MANUAL

When you choose R-Shield® Nailstrip, you're collaborating with a team of experts who work with you every step of the way. We're here to answer your questions, solve your problems, and do everything we can to make sure your project proceeds smoothly—and ends successfully.

R-Shield products are manufactured by Premier Building Systems. Premier Building Systems adheres to strict, consistent standards to ensure high-quality.

This network allows us to offer architects, designers and builders the best of both worlds: the resources of the country's largest provider of Nailstrip products and systems, and the superior attention and customer service of a local supplier.

Note: Information deemed reliable at time of printing.
Please visit: www.rshieldinsulation.com for the latest information.
Sept. 2022.

Table of Contents

R-Shield Nailstrip

Details

General

R-Shield Nailstrip	FC-300
General Notes	FC-300a
Vertical Installation	FC-301
Horizontal Installation	FC-301a
Optional Electrical Chases	FC-302
Electrical Box	FC-303

Interior

Interior Top of Wall	FC-402
Interior Top of Wall	FC-402a
Interior Bottom of Wall	FC-403
Interior Opening Header	FC-404
Interior Opening Sill	FC-405
Interior Opening Jamb	FC-406
Interior Outside Corner	FC-407
Interior Inside Corner	FC-408

Exterior

Exterior Top of Wall	FC-502
Exterior Top of Wall	FC-502a
Exterior Bottom of Wall	FC-503
Exterior Bottom of Wall	FC-503a
Exterior Opening Header	FC-504
Exterior Opening Sill	FC-505
Exterior Opening Jamb	FC-506
Exterior Outside Corner	FC-507
Exterior Outside Corner	FC-507a
Exterior Inside Corner	FC-508
Exterior Inside Corner	FC-508a

Technical Bulletins

Substrate Preparation and Installation	Nailstrip No. 8001
Rainscreens	Nailstrip No. 8002

General Recommendations

R-Shield Nailstrip Sizes

R-Shield Nailstrip is made in a variety of sizes, most commonly 4' x 8'. Consult Premier Building Systems for sizes, thicknesses, and fabrication services available in your area.

Environmentally Safe

The core material for R-Shield Nailstrip, R-Shield insulation, contains no CFCs, HCFCs, HFCs or formaldehyde and is recyclable. R-Shield insulation is inert, non-nutritive and highly stable. Premier Building Systems encourages you to support recycling and energy conservation.

Warranty

Premier Building Systems provide a 50-year warranty covering thermal performance. Contact Premier Building Systems for details regarding the warranty program.

Handling - Storage - Protection

R-Shield Nailstrip should be stored in a fully supported manner and protected from weather. Cover stored R-Shield Nailstrip with tarps or similar protective wraps. Exposure 1 OSB facings are used in R-Shield Nailstrip manufacture; however, exterior wall installations must be covered by a code recognized weather resistive barrier applied at the time of installation. Apply wall cladding when immediately practical.

Expanded polystyrene contains a flame retardant additive. However, the expanded polystyrene should be considered combustible and used with code approved thermal barriers and should not be stored near any open flame or source of ignition. Do not install or use expanded polystyrene with coal-tar pitch or highly solvent extended mastics, adhesives or sealants. Consult Premier Building System for suggested adhesives, sealants, and assembly specifications not otherwise detailed in this manual.

General Recommendations - cont'd

Vapor Retarders

R-Shield Nailstrip may require the use of a vapor retarder. Consult with a local design professional for a recommendation.

Special Treatments

One of the most destructive forces anywhere is termites. R-Shield can be manufactured with a proven and safe additive, that effectively resists termites.

R-Shield is treated to meet ICC ES AC239, "Acceptance Criteria for Termite-Resistant Foam Plastics."

Disclaimer

Details, illustrations, pictures and guidelines provided herein give basic information and illustrate examples of R-Shield Nailstrip installation. The basic information provide herein is not intended to cover every potential use and application of R-Shield Nailstrip. It is the responsibility of the installer to become familiar with his specific application and determine if R-Shield Nailstrip is suitable. By commencing work, the installer accepts full responsibility for the proper and safe installation of R-Shield Nailstrip at his job site. Adding an insulation component may change the behavior of a wall assembly with regard to air movement, water vapor transmittance, bulk water management and heating, cooling and ventilation systems. It is the responsibility of the owner or the owner's representative to design the insulated wall assembly to perform in a manner ensuring function and durability. Furthermore, it is the sole responsibility of the installer to meet all federal and local regulatory requirements for job site safety for himself, his workers and any others on the job site while in the execution of all phases of R-Shield Nailstrip installation.

ASTM C578 Type I
ICC-ES ESR-1006
Thickness Varies

2" Wide Strips of 7/16"
Oriented Strand Board
(OSB) DOC-PS2
EXPOSURE 1
16" o.c. Typical

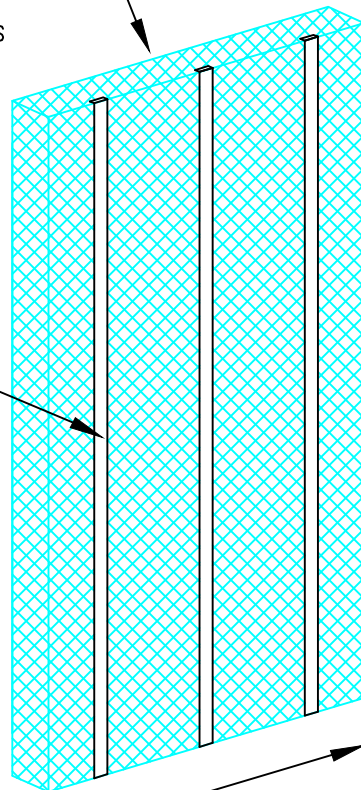

8', 9', 10'
Length Typical

4' Width Typical

ISOMETRIC

SCALE: NTS

Updated 6-1-20

Nailstrip

TITLE:
Nailstrip

NO.
NS-300

General Notes

1. Provide adequate support for Nailstrip during storage.
2. Store Nailstrip flat and protected from weather.
3. Exterior applications:
Nailstrip must be covered with code recognized weather resistive barrier at time of installation. Apply wall covering to Nailstrip following wall covering manufacturer recommendations. Fasten trim to Nailstrip or wood blocking as required.
4. Interior applications:
Nailstrip must be covered with code approved thermal barrier. Fasten thermal barrier to Nailstrip or wood blocking as required.
5. Attachment of Nailstrip shall be with screws into structural members/substrate.
6. Each project shall be engineered as required.
7. Details provided are illustrative examples of Nailstrip installation and not intended to cover every potential use and application.

Updated 6-1-20

Nailstrip

TITLE:
GENERAL NOTES

NO.
NS-300a

Note: Screw Pattern Illustrated
Is Representative. Each Project
Shall Be Engineered As Required.

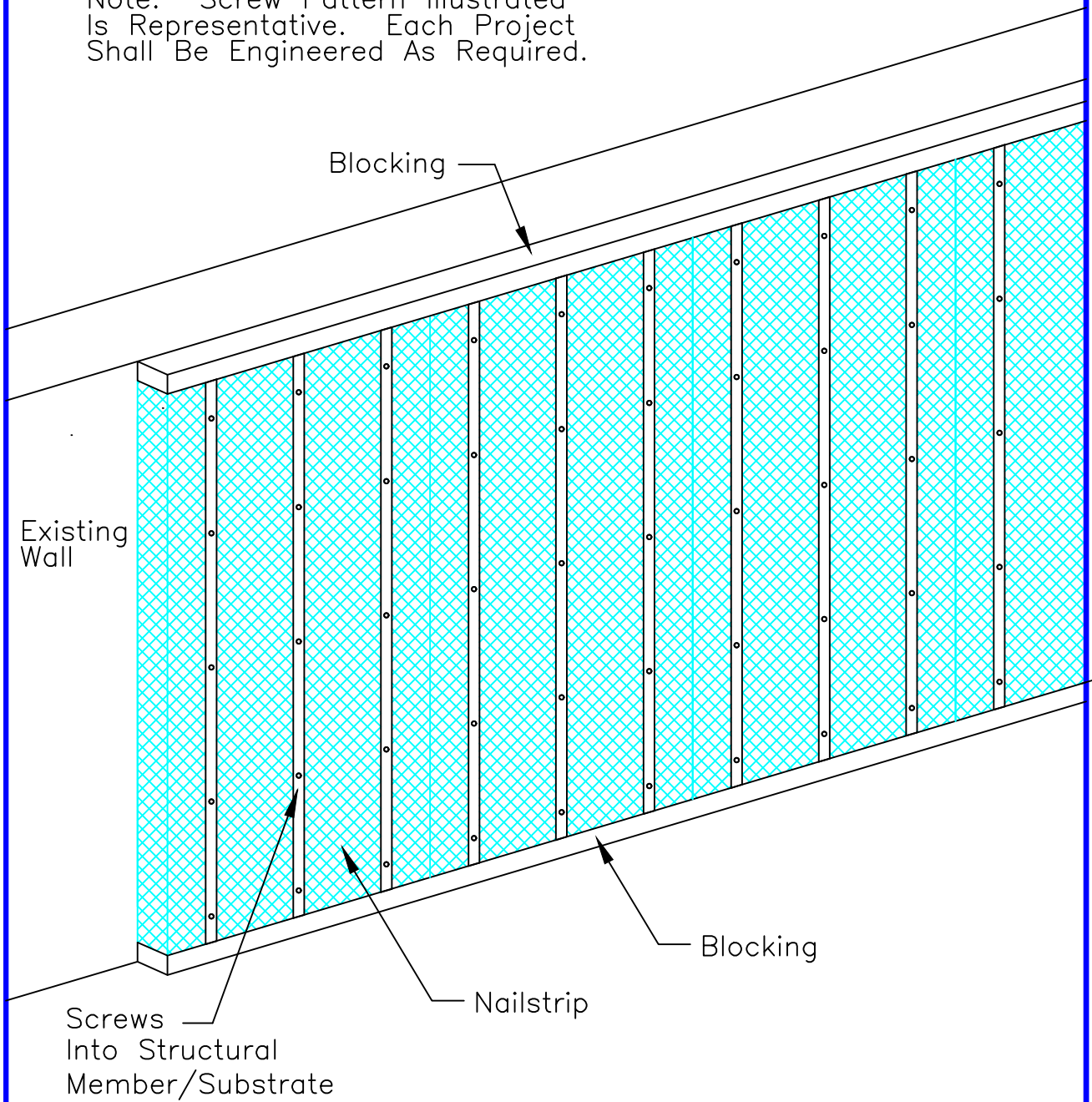

ISOMETRIC

SCALE: NTS

Updated 6-1-20

Nailstrip

TITLE:
VERTICAL INSTALLATION

NO.
NS-301

Note: Screw Pattern Illustrated
Is Representative. Each Project
Shall Be Engineered As Required.

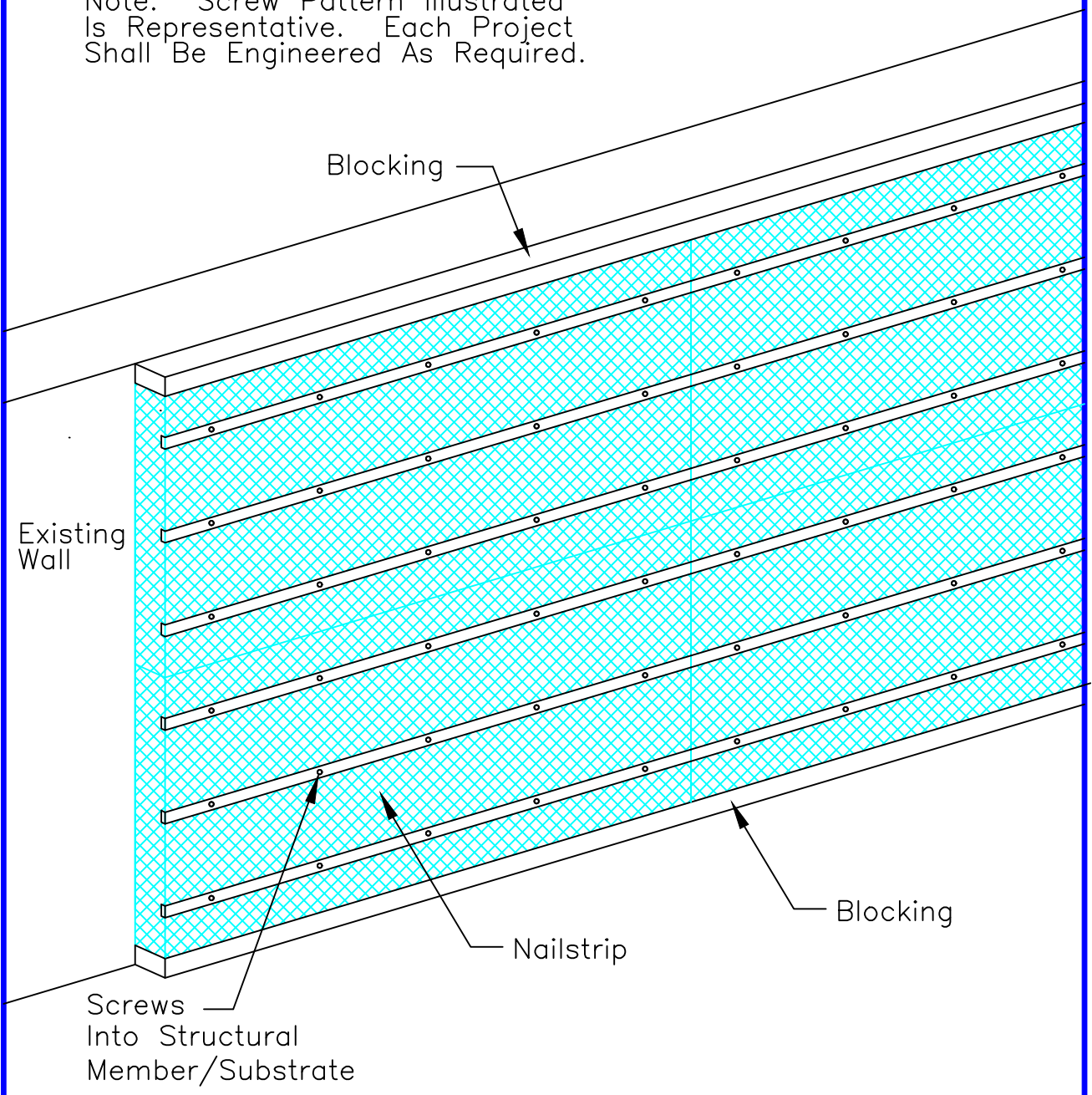

ISOMETRIC

SCALE: NTS

Updated 6-1-20

Nailstrip

TITLE:
HORIZONTAL INSTALLATION

NO.
NS-301a

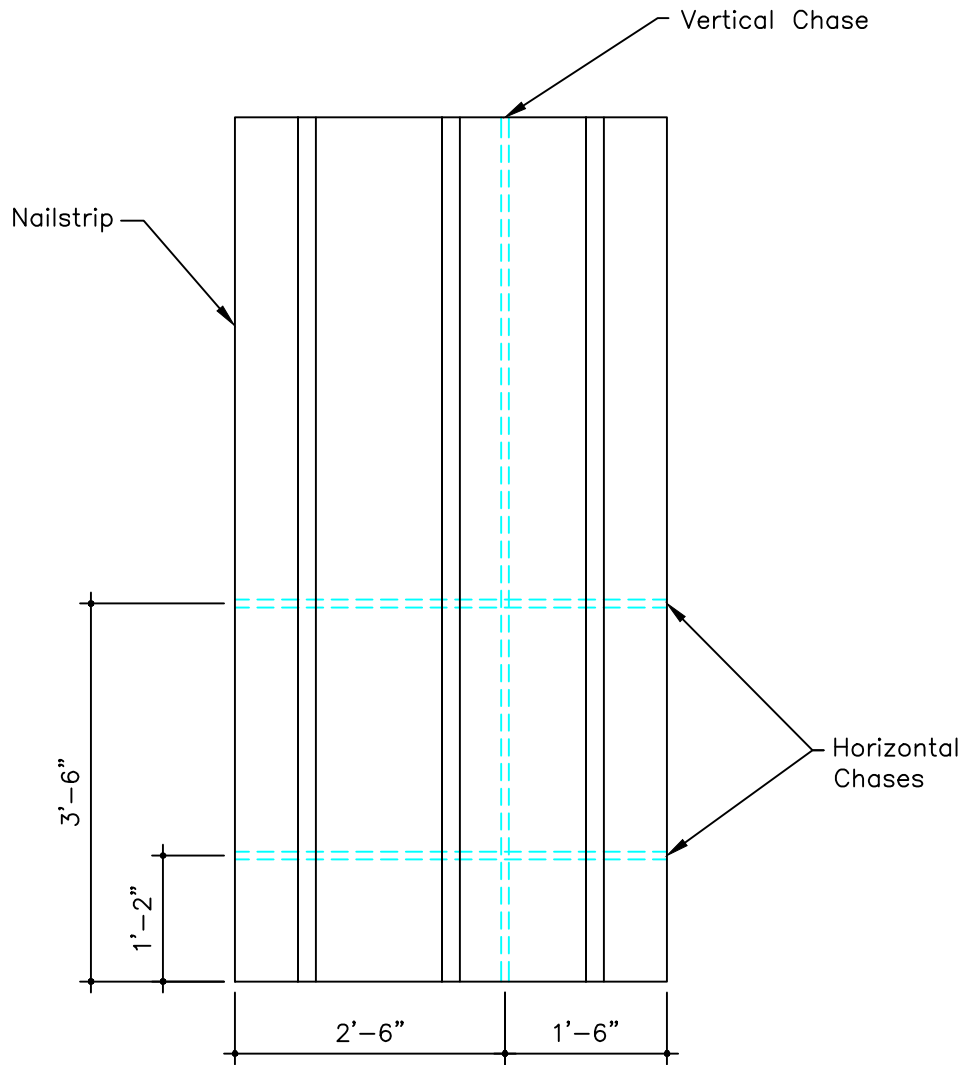

ELEVATION

SCALE: NTS

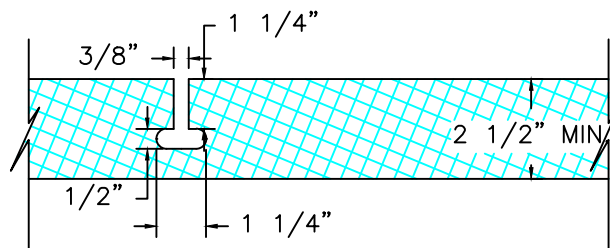

SECTION

SCALE: NTS

Updated 6-1-20

Nailstrip

TITLE:
OPTIONAL ELECTRICAL CHASES

NO.
NS-302

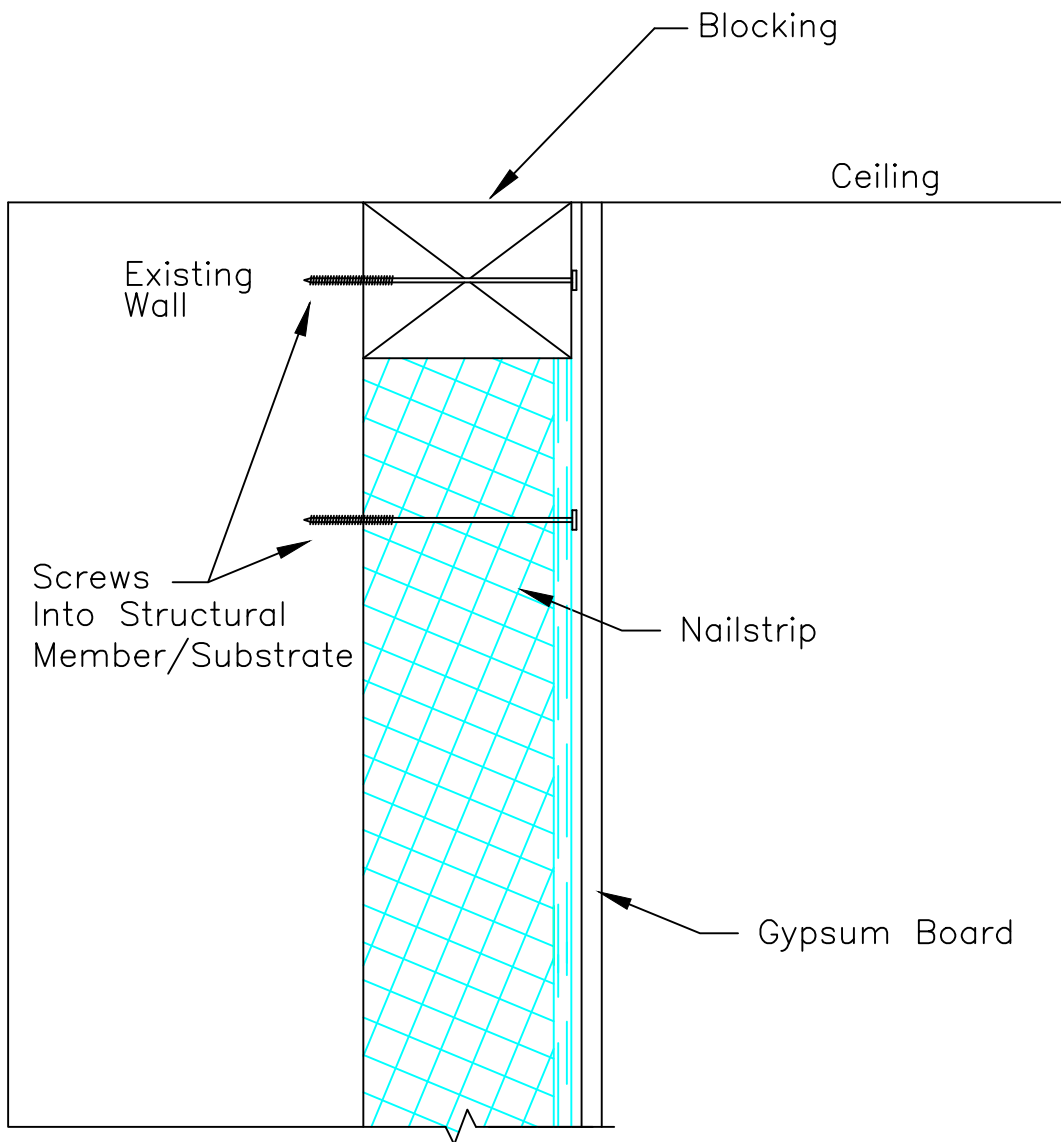

SECTION

SCALE: NTS

Updated 6-1-20

Nailstrip

TITLE:
INTERIOR TOP OF WALL

NO.
NS-402a

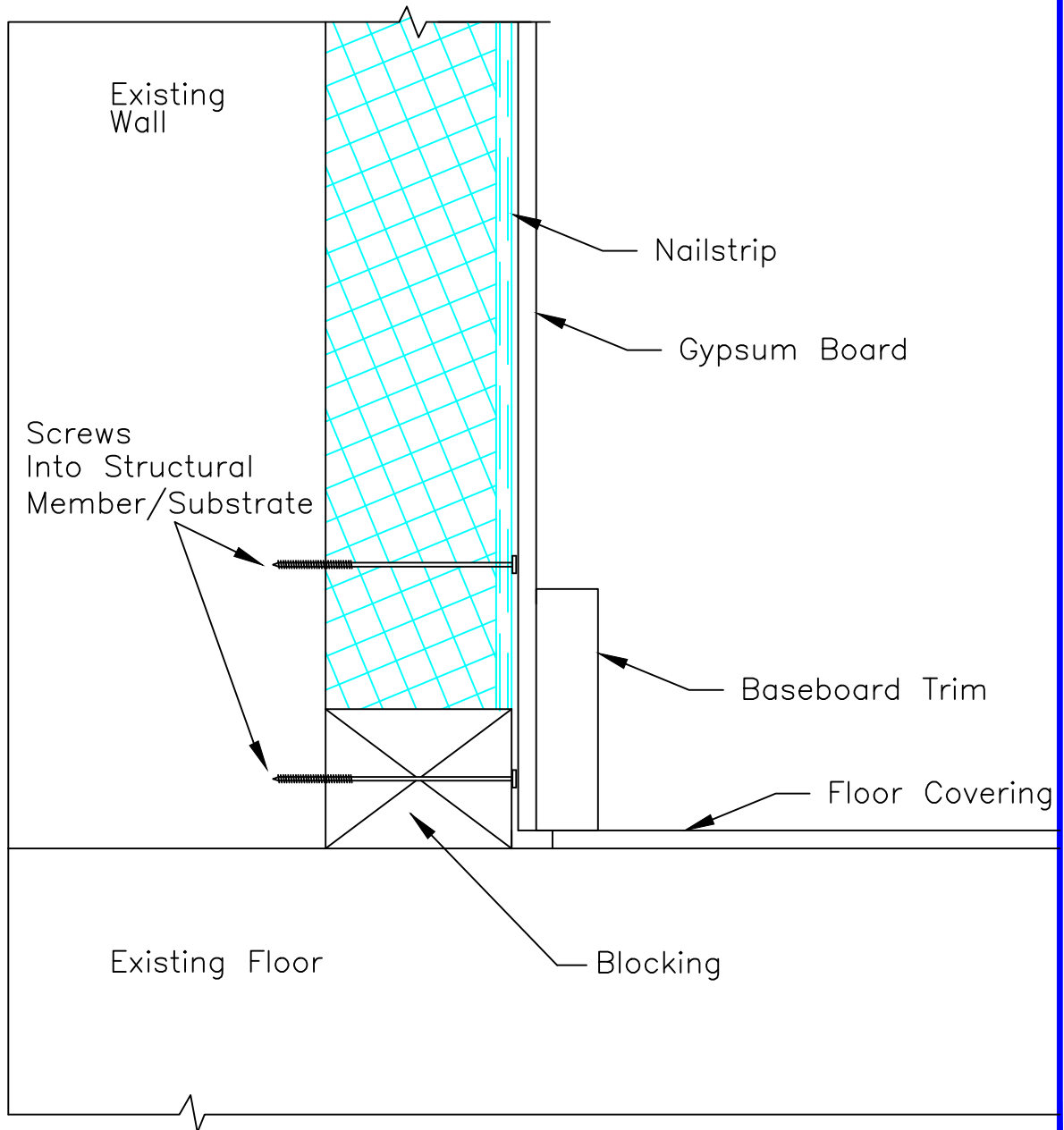

SECTION

SCALE: NTS

Updated 6-1-20

Nailstrip

TITLE:
INTERIOR BOTTOM OF WALL

NO.
NS-403

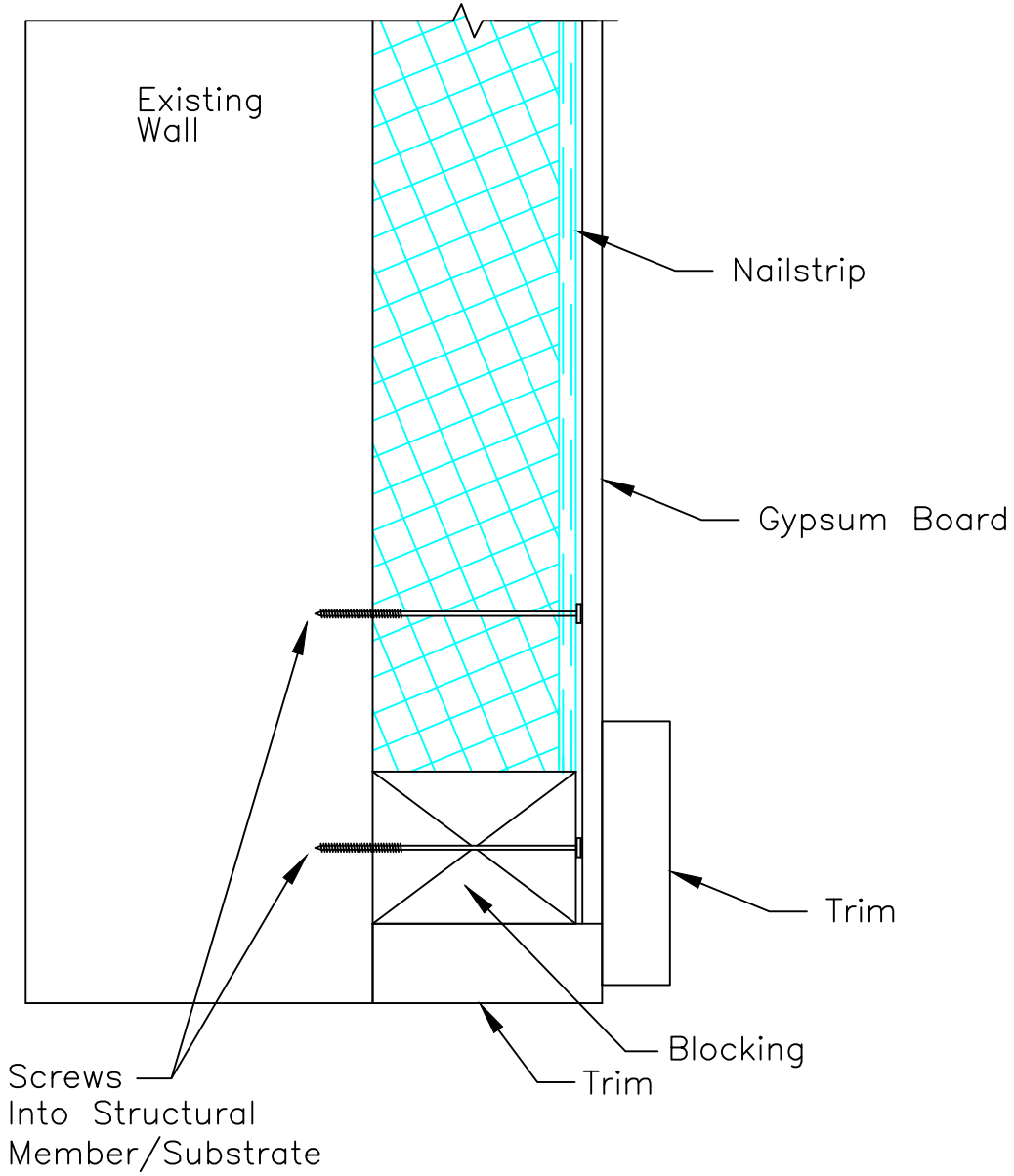

SECTION

SCALE: NTS

Updated 6-1-20

Nailstrip

TITLE: INTERIOR OPENING HEADER	NO. NS-404
-----------------------------------	---------------

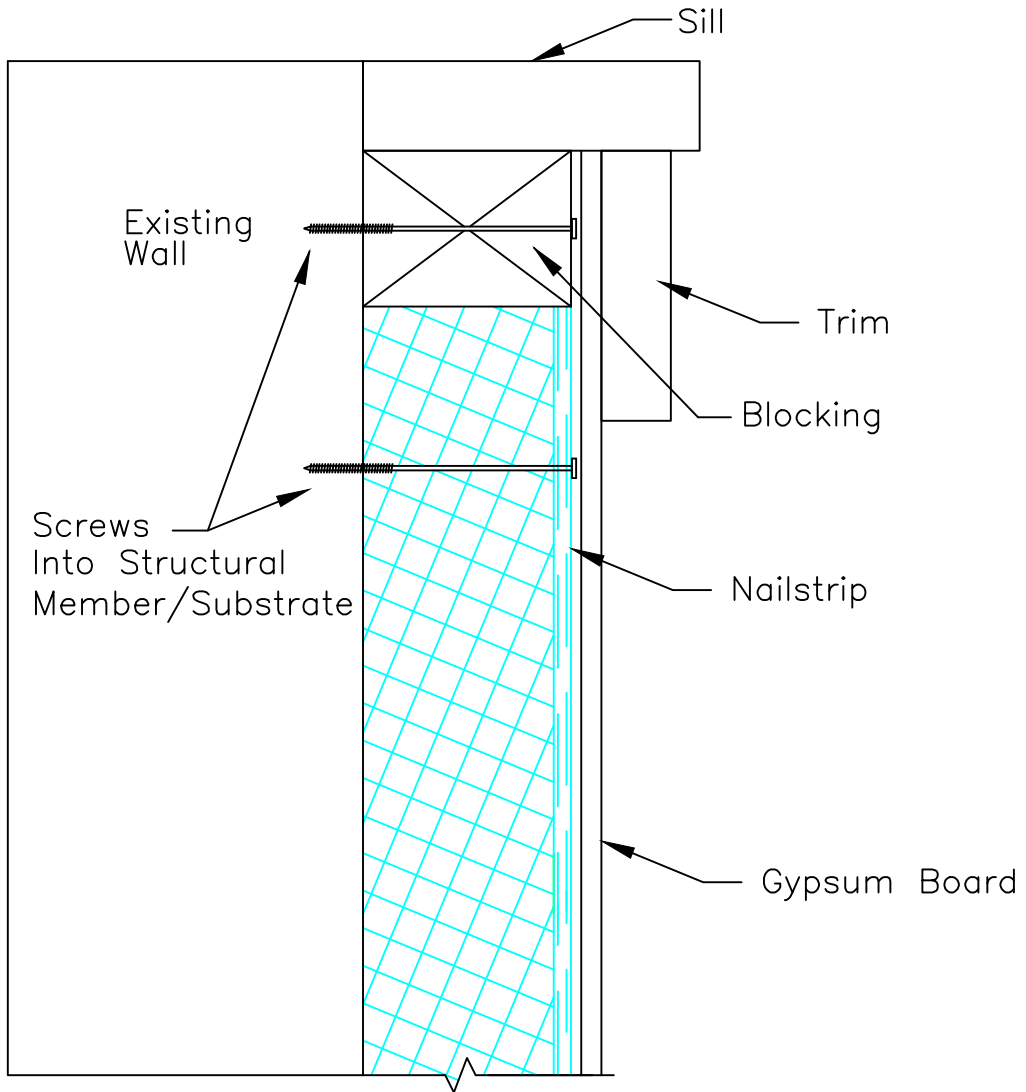

SECTION

SCALE: NTS

Updated 6-1-20

Nailstrip

TITLE:
INTERIOR OPENING SILL

NO.
NS-405

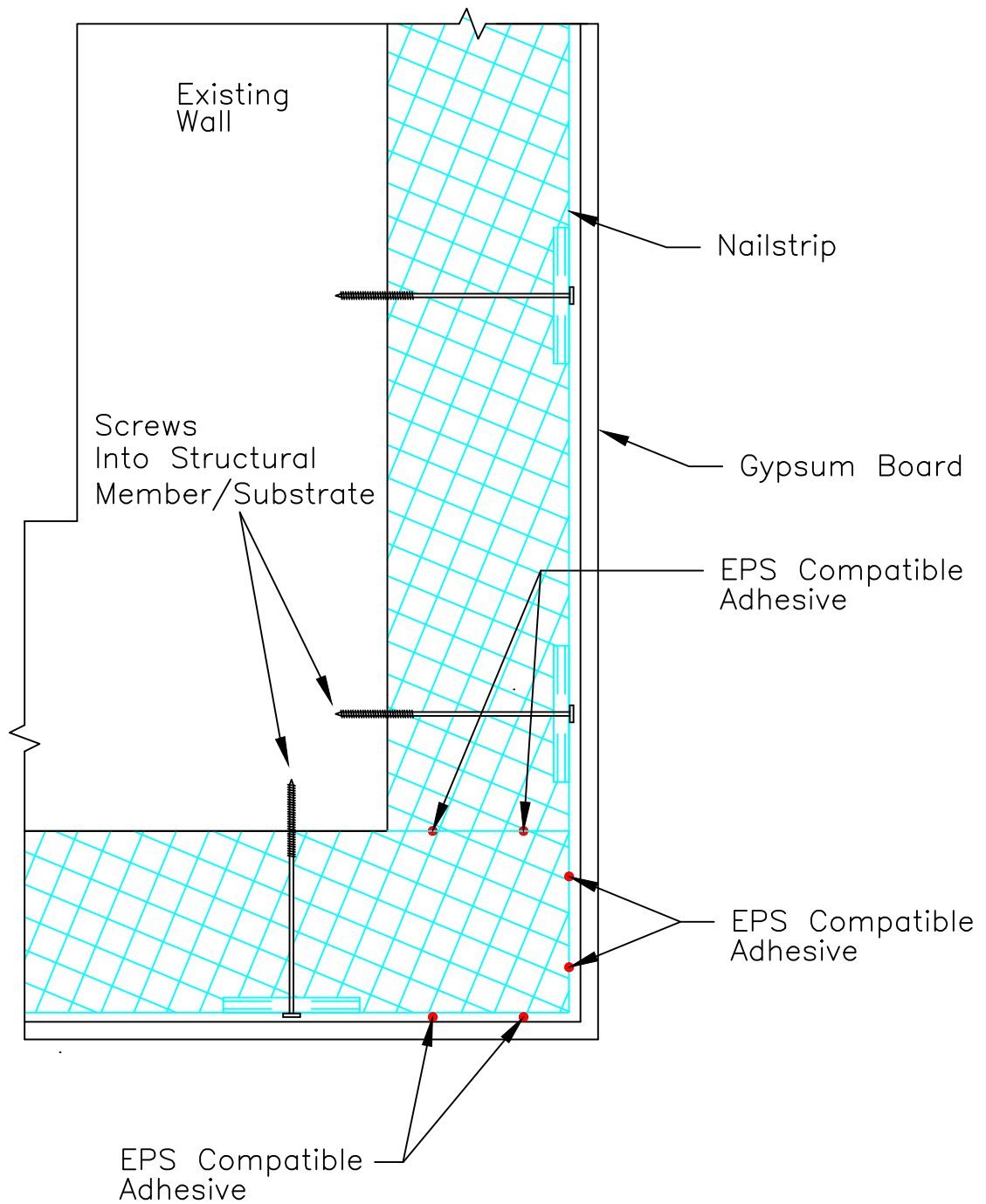

SECTION

SCALE: NTS

Updated 6-1-20

Nailstrip

TITLE:
INTERIOR OUTSIDE CORNER

NO.
NS-407

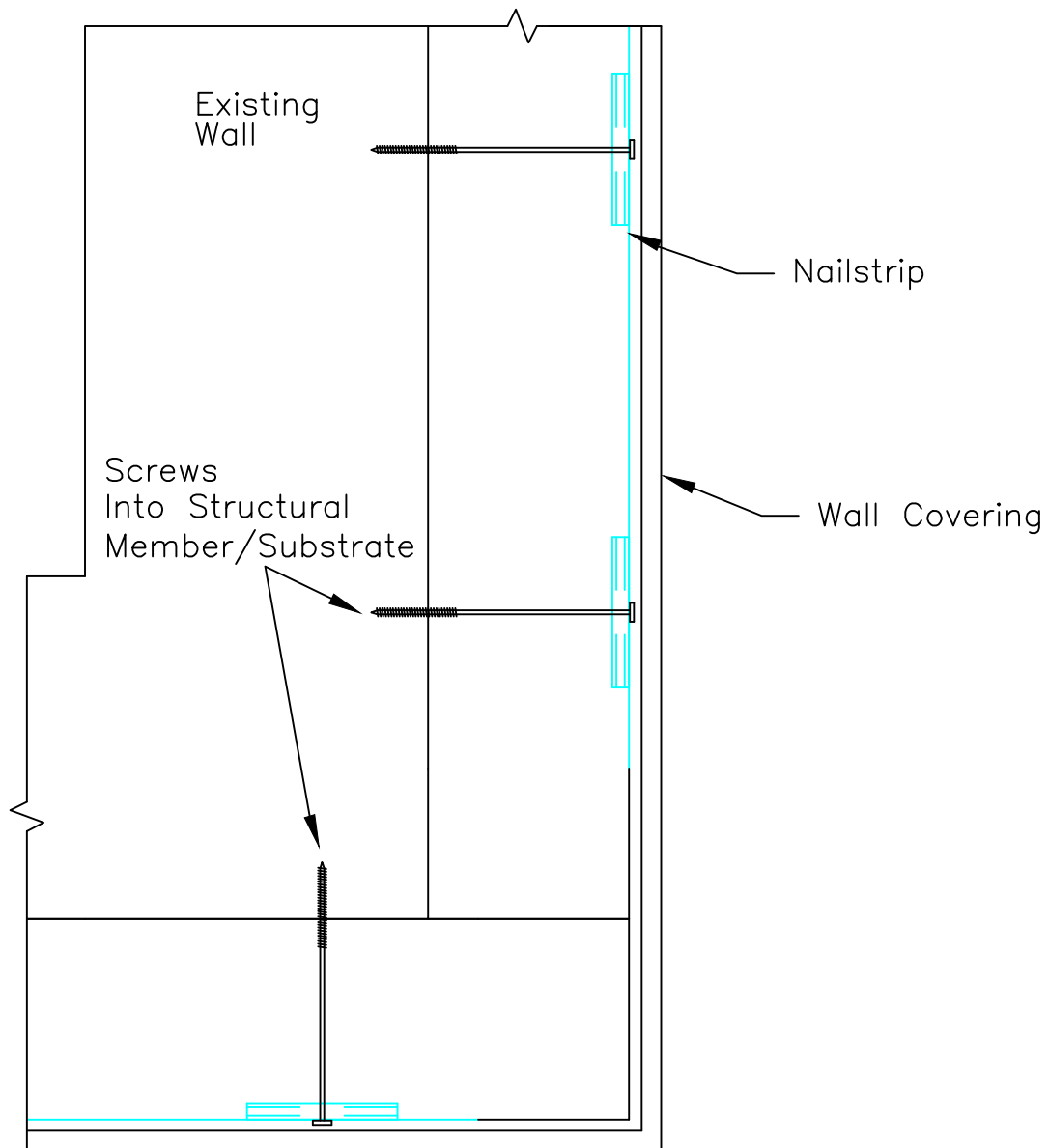

SECTION

SCALE: NTS

Updated 6-1-20

Nailstrip

TITLE:
INTERIOR OUTSIDE CORNER

NO.
NS-407a

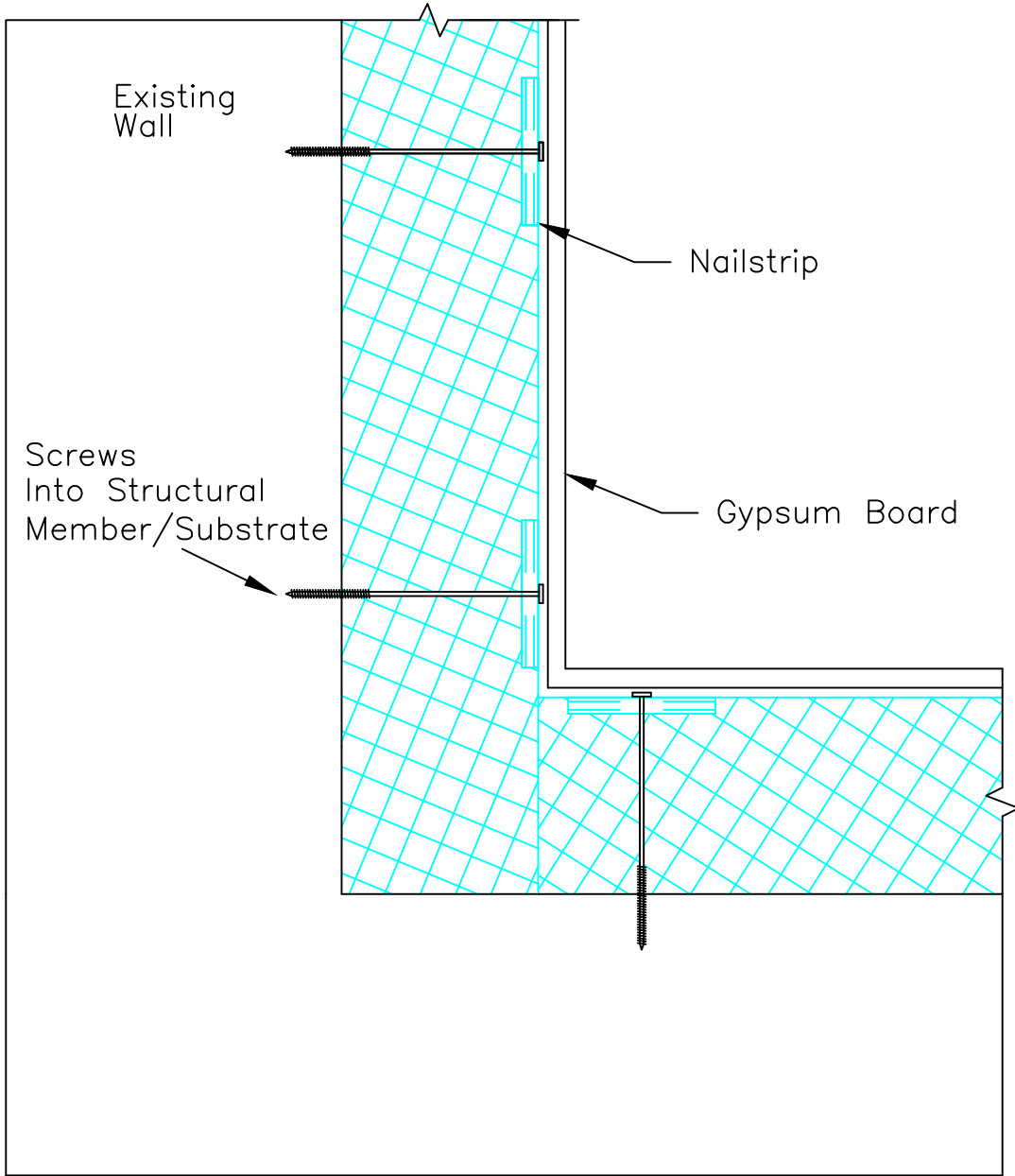

SECTION

SCALE: NTS

Updated 6-1-20

Nailstrip

TITLE:
INTERIOR INSIDE CORNER

NO.
NS-408

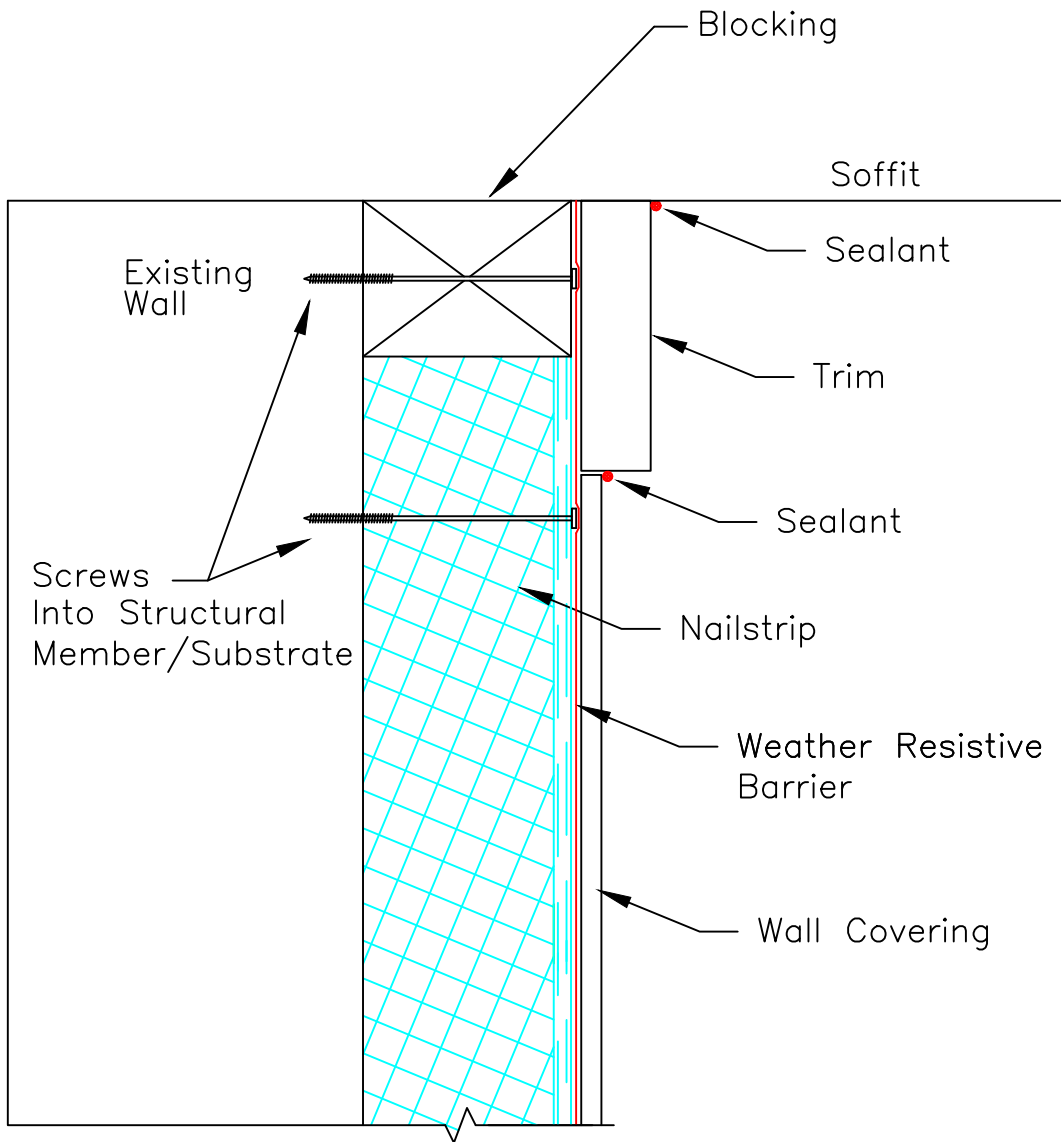

SECTION

SCALE: NTS

Updated 6-1-20

Nailstrip

TITLE:
EXTERIOR TOP OF WALL

NO.
NS-502

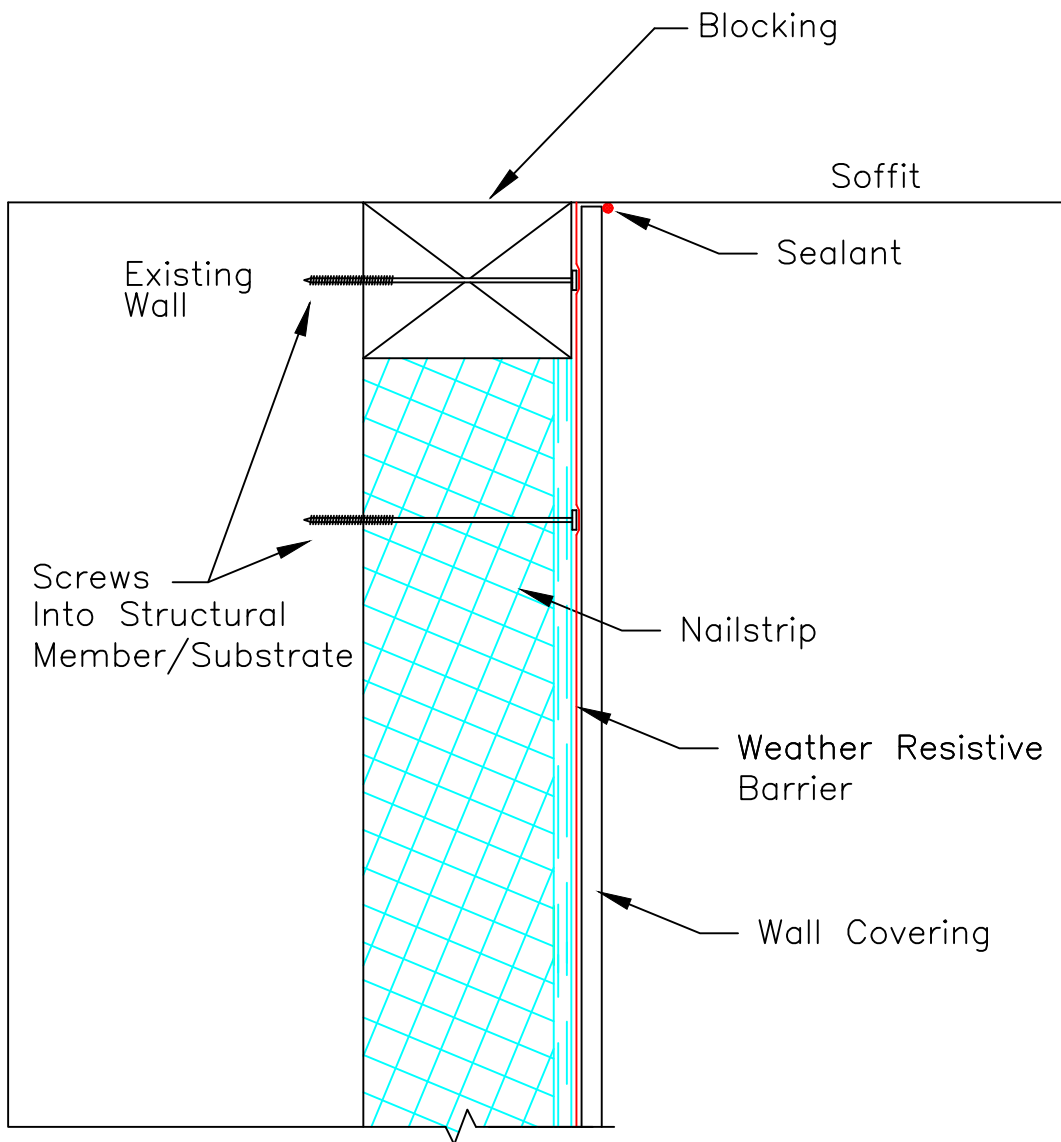

SECTION

SCALE: NTS

Updated 6-1-20

Nailstrip

TITLE:
EXTERIOR TOP OF WALL

NO.
NS-502a

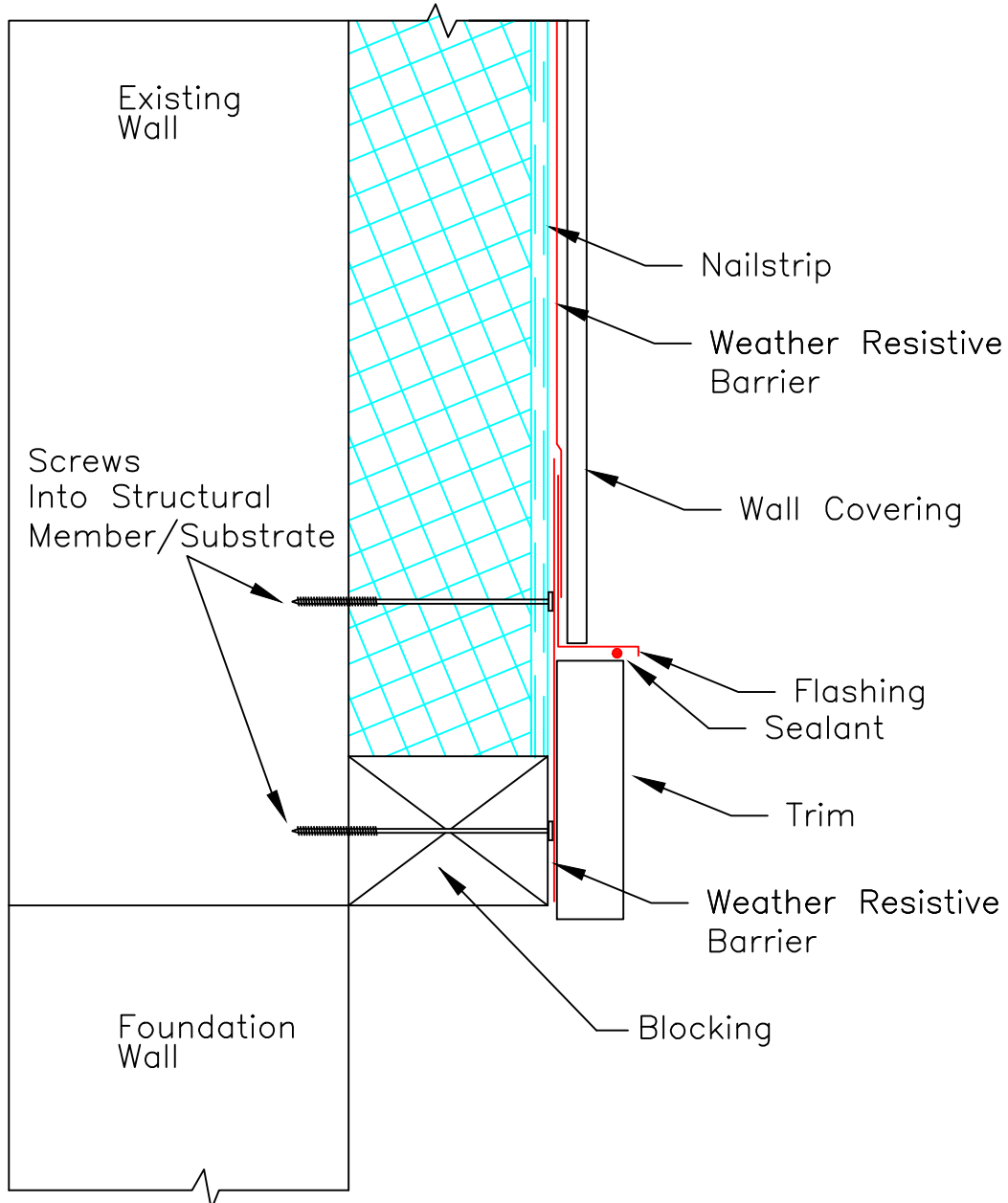

SECTION

SCALE: NTS

Updated 6-1-20

Nailstrip

TITLE:
EXTERIOR BOTTOM OF WALL

NO.
NS-503

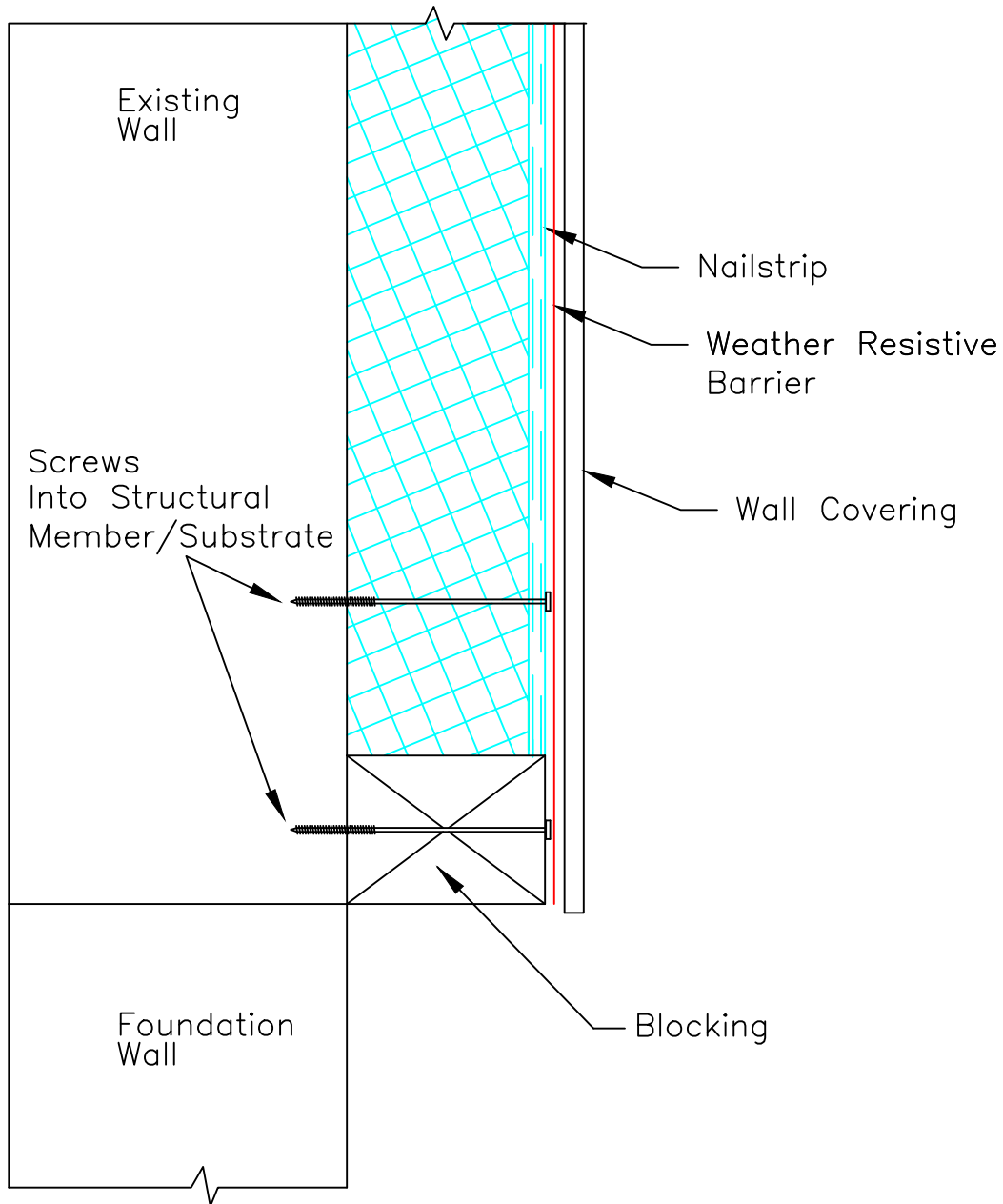

SECTION

SCALE: NTS

Updated 6-1-20

Nailstrip

TITLE:
EXTERIOR BOTTOM OF WALL

NO.
NS-503a

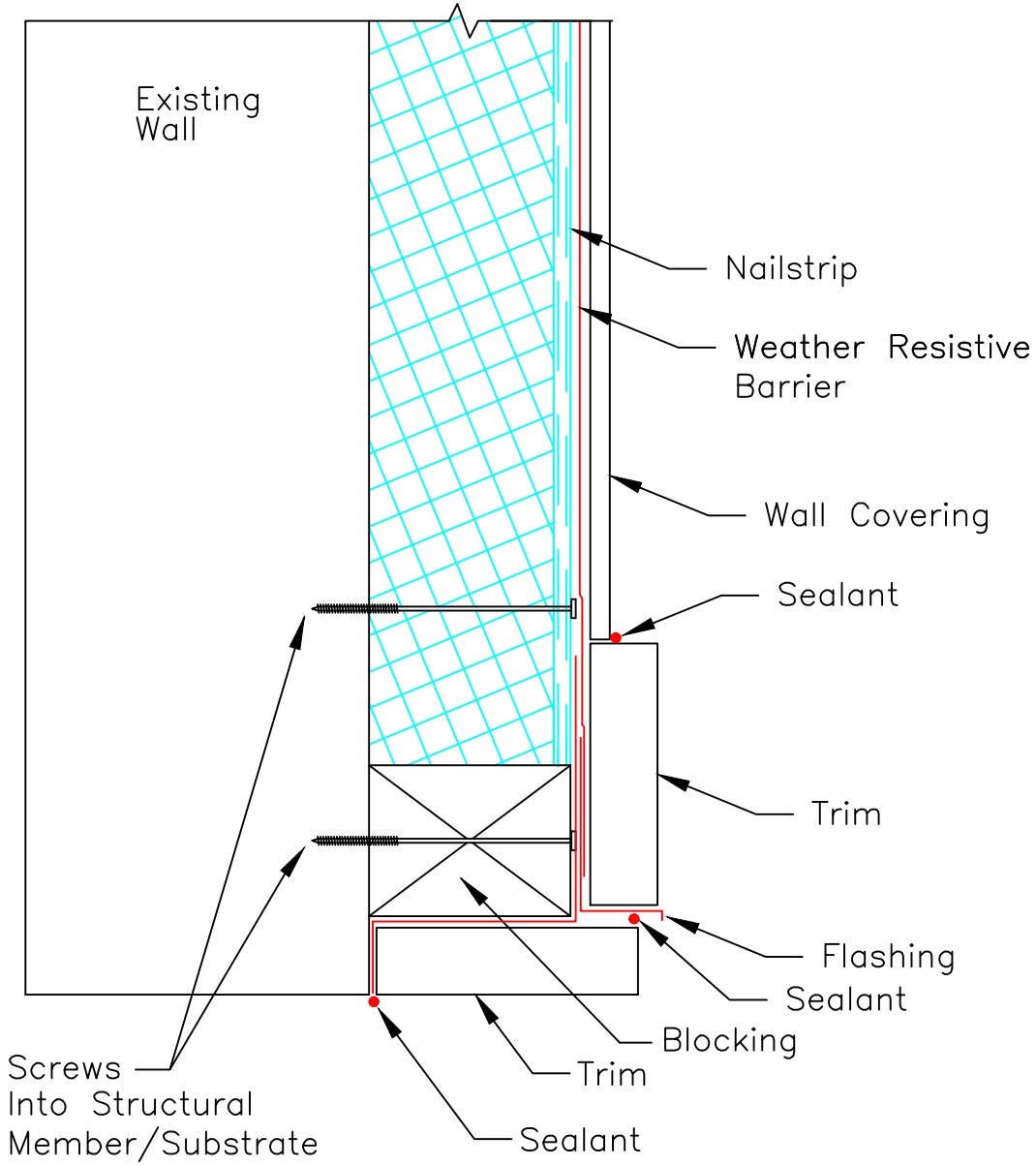

SECTION
SCALE: NTS

Updated 6-1-20

Nailstrip

TITLE: EXTERIOR OPENING HEADER	NO. NS-504
-----------------------------------	---------------

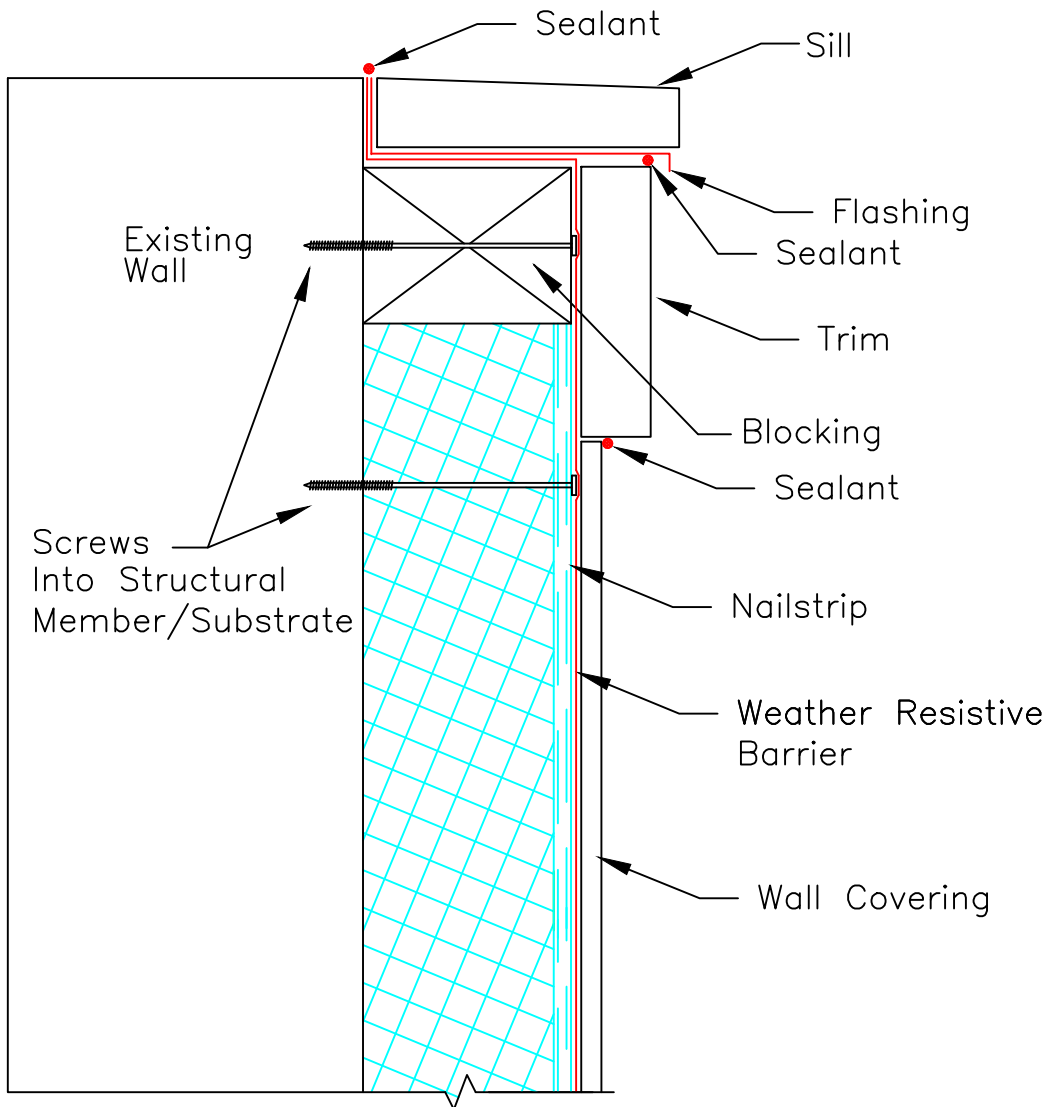

SECTION

SCALE: NTS

Updated 6-1-20

Nailstrip

TITLE:
EXTERIOR OPENING SILL

NO.
NS-505

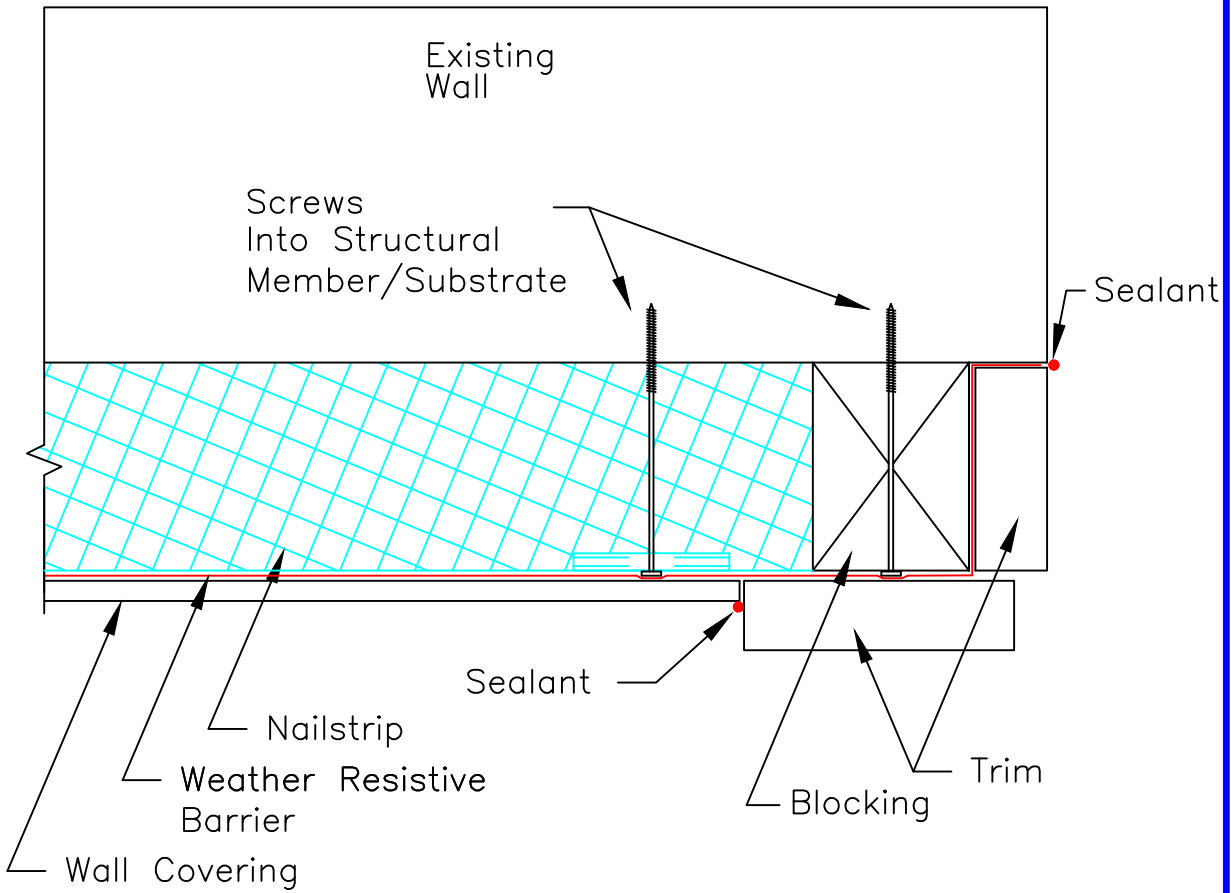

SECTION

SCALE: NTS

Updated 6-1-20

Nailstrip

TITLE:
EXTERIOR OPENING JAMB

NO.
NS-506

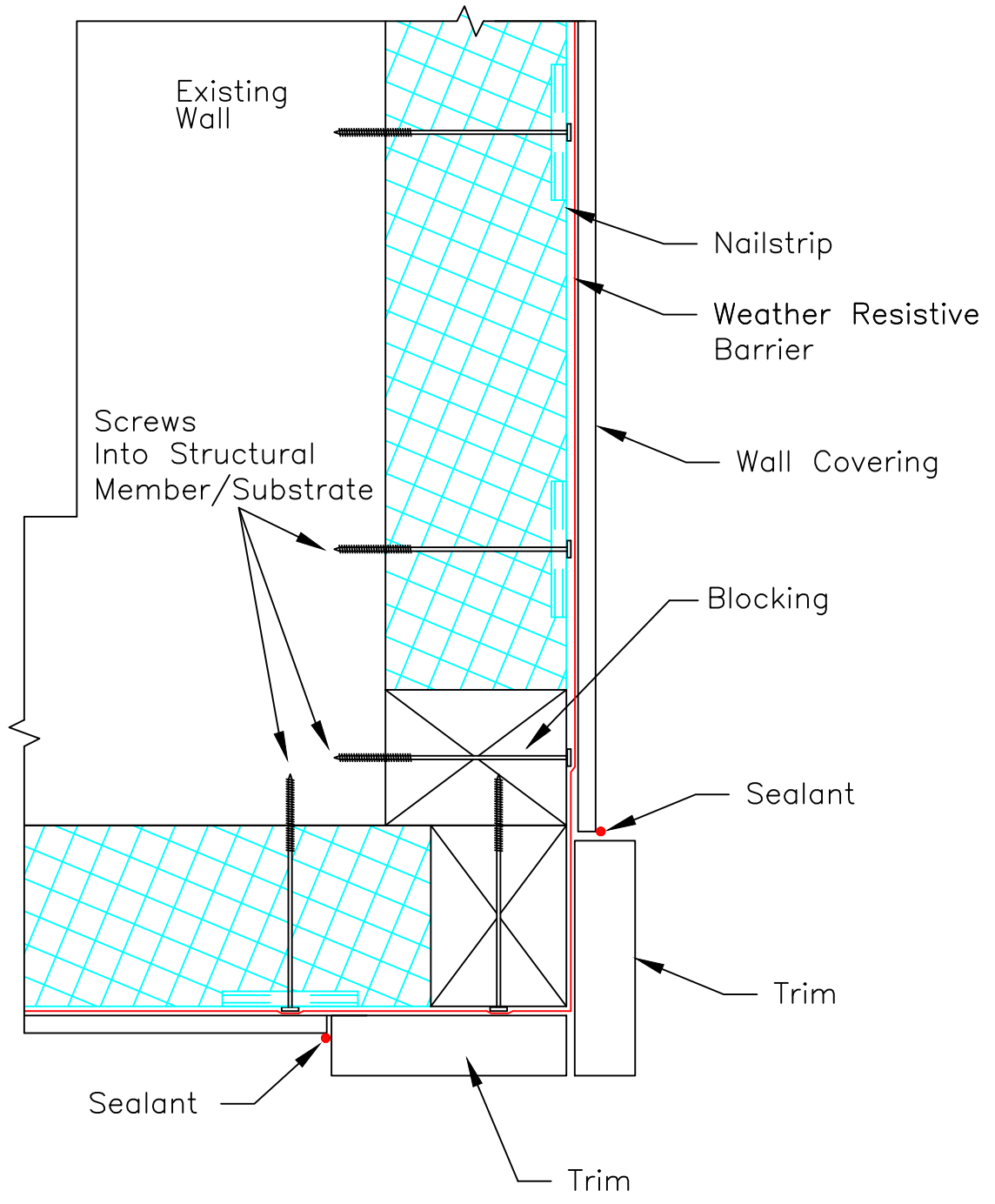

SECTION

SCALE: NTS

Updated 6-1-20

Nailstrip

TITLE:
EXTERIOR OUTSIDE CORNER

NO.
NS-507

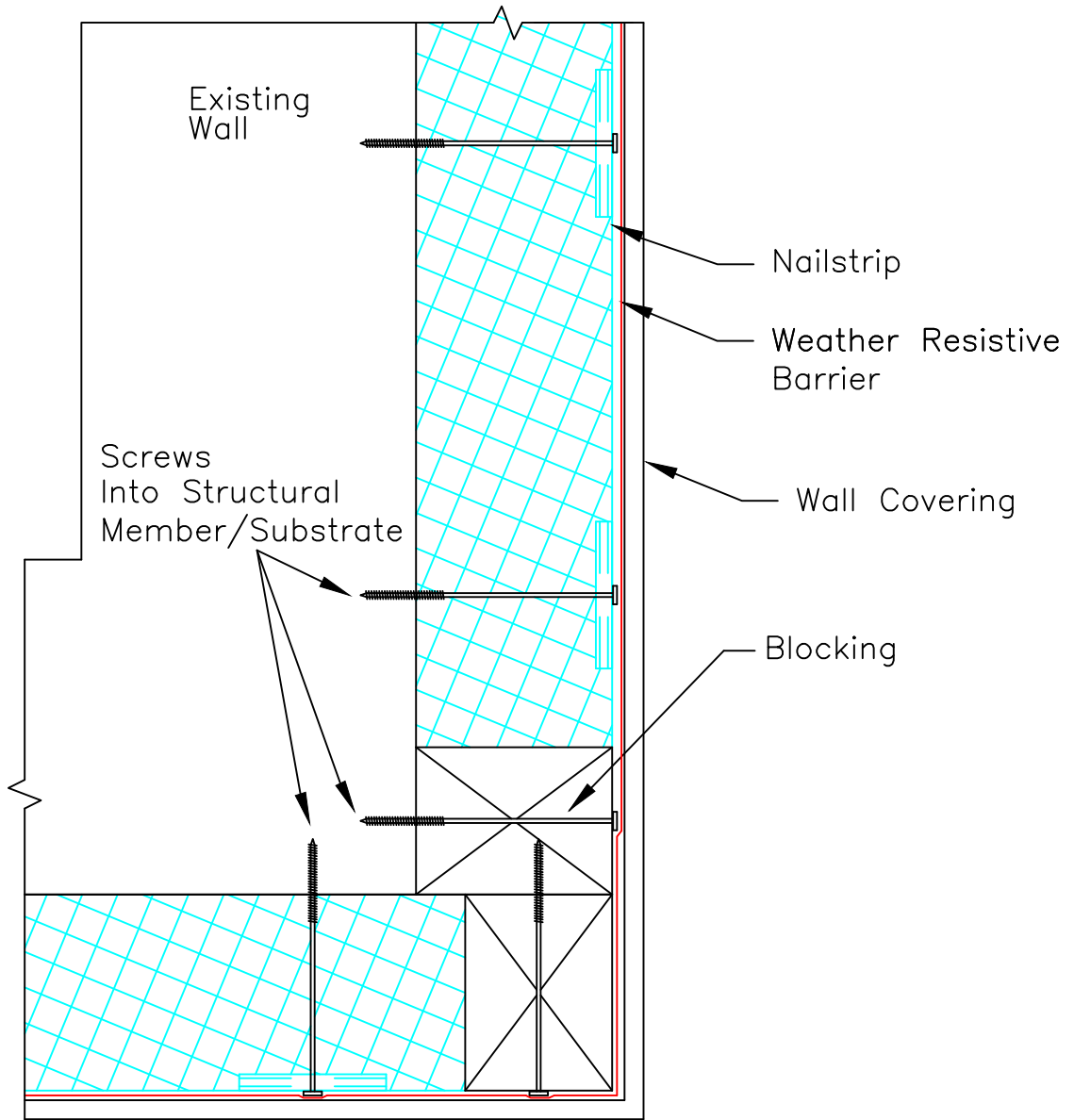

SECTION

SCALE: NTS

Updated 6-1-20

Nailstrip

TITLE:
EXTERIOR OUTSIDE CORNER

NO.
NS-507a

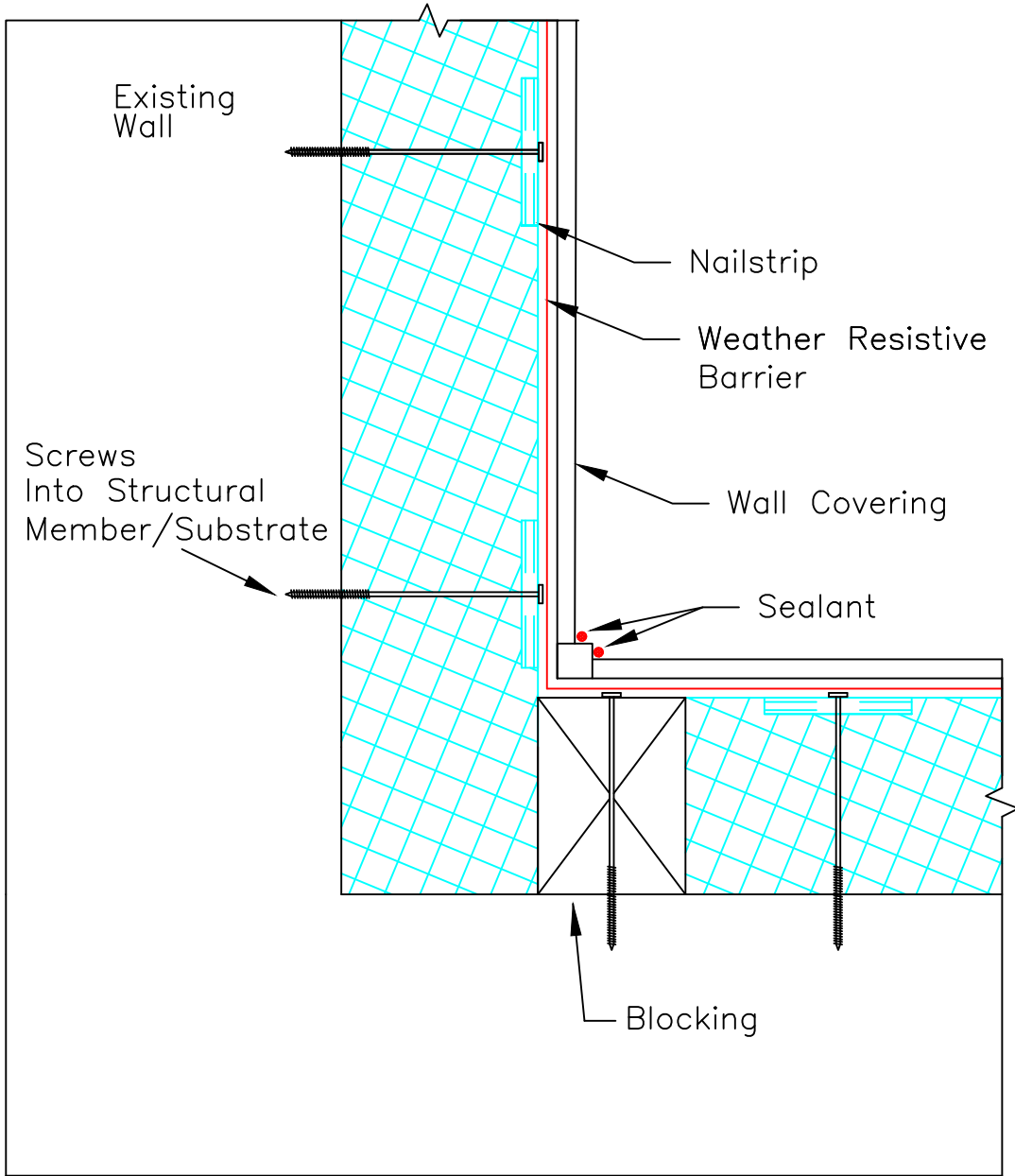

SECTION

SCALE: NTS

Updated 6-1-20

Nailstrip

TITLE:
EXTERIOR INSIDE CORNER

NO.
NS-508

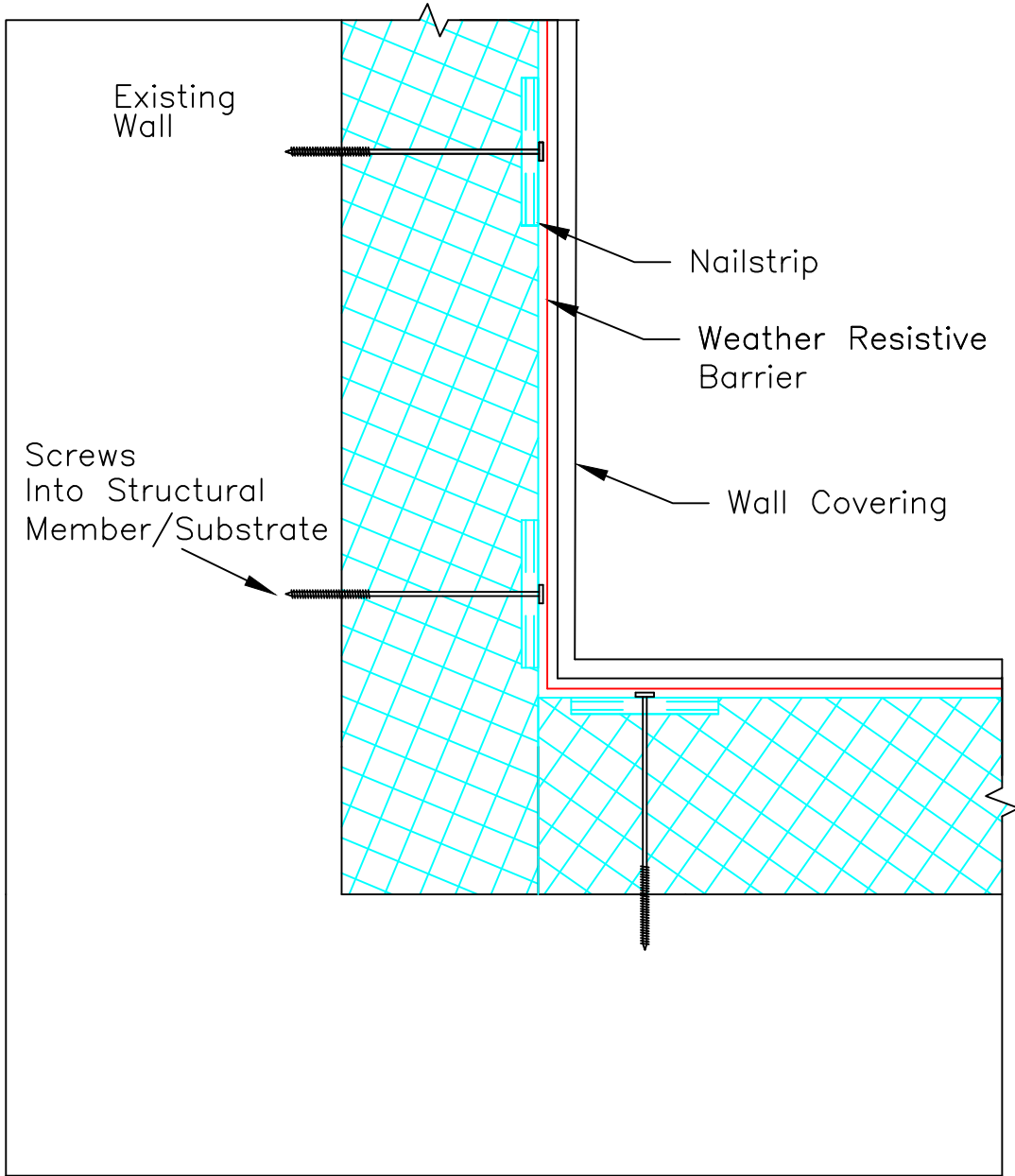

SECTION

SCALE: NTS

Updated 6-1-20

Nailstrip

TITLE:
EXTERIOR INSIDE CORNER

NO.
NS-508a

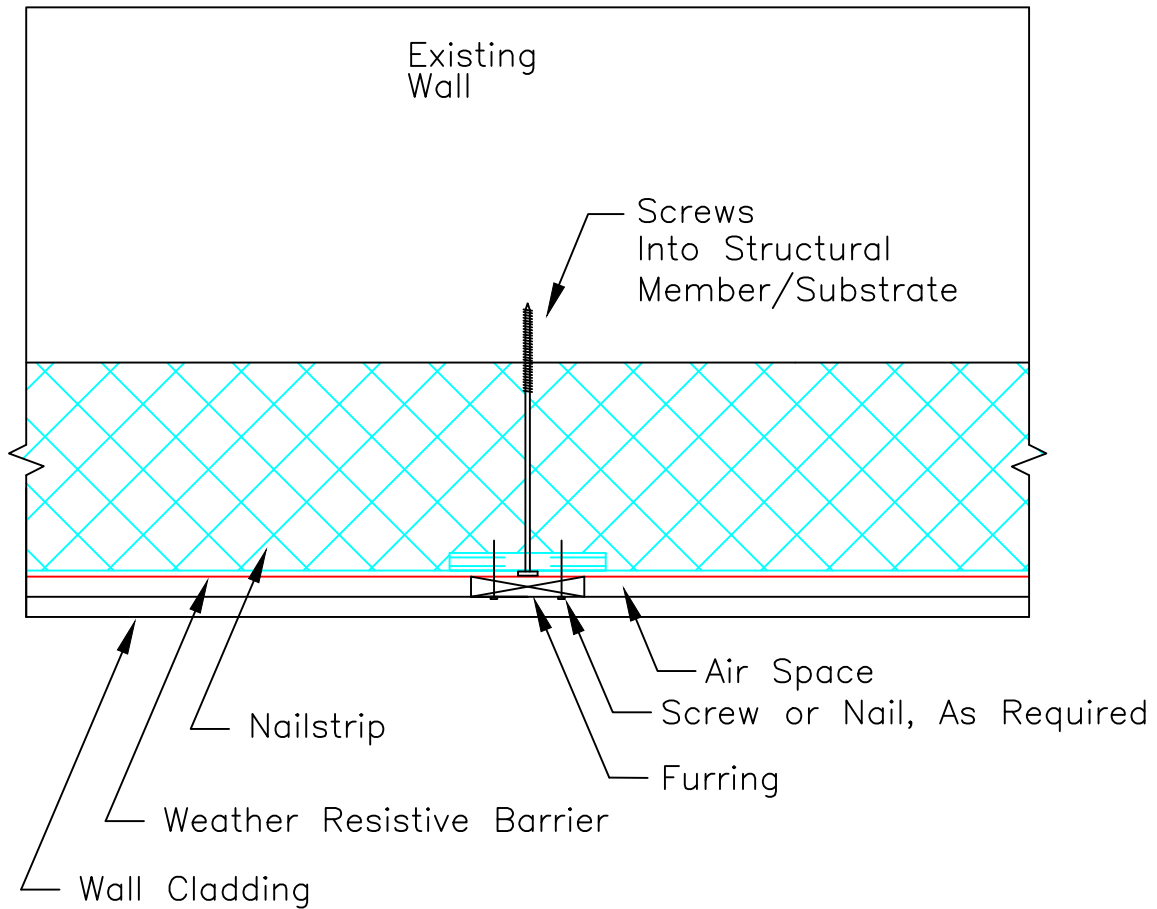

SECTION

SCALE: NTS

Updated 6-1-20

Nailstrip

TITLE:
Rainscreen

NO.
NS-600

Product Availability and Support.

R-Shield Nailstrip is supported by a team of experts who work with you to answer your questions, offer solutions, and do everything they can to make sure your project goes smoothly and ends successfully.

Ready to take control? Start here.

If you're ready to have R-Shield Nailstrip contribute to your next project, just contact your Premier Building Systems Technical Sales Representative. We will be happy to give you design consultation, information about R-Shield Nailstrip products, pricing, and answers to all of your questions.

A PRODUCT OF
PREMIER
BUILDING SYSTEMS



www.rshieldinsulation.com | 800-766-3626

Copyright © 2022. R-Shield is a registered trademark of Premier Building Systems. RSI NS02 08/22